

UHMW Rail Covers Available from stock in 10 or 20 ft. lengths

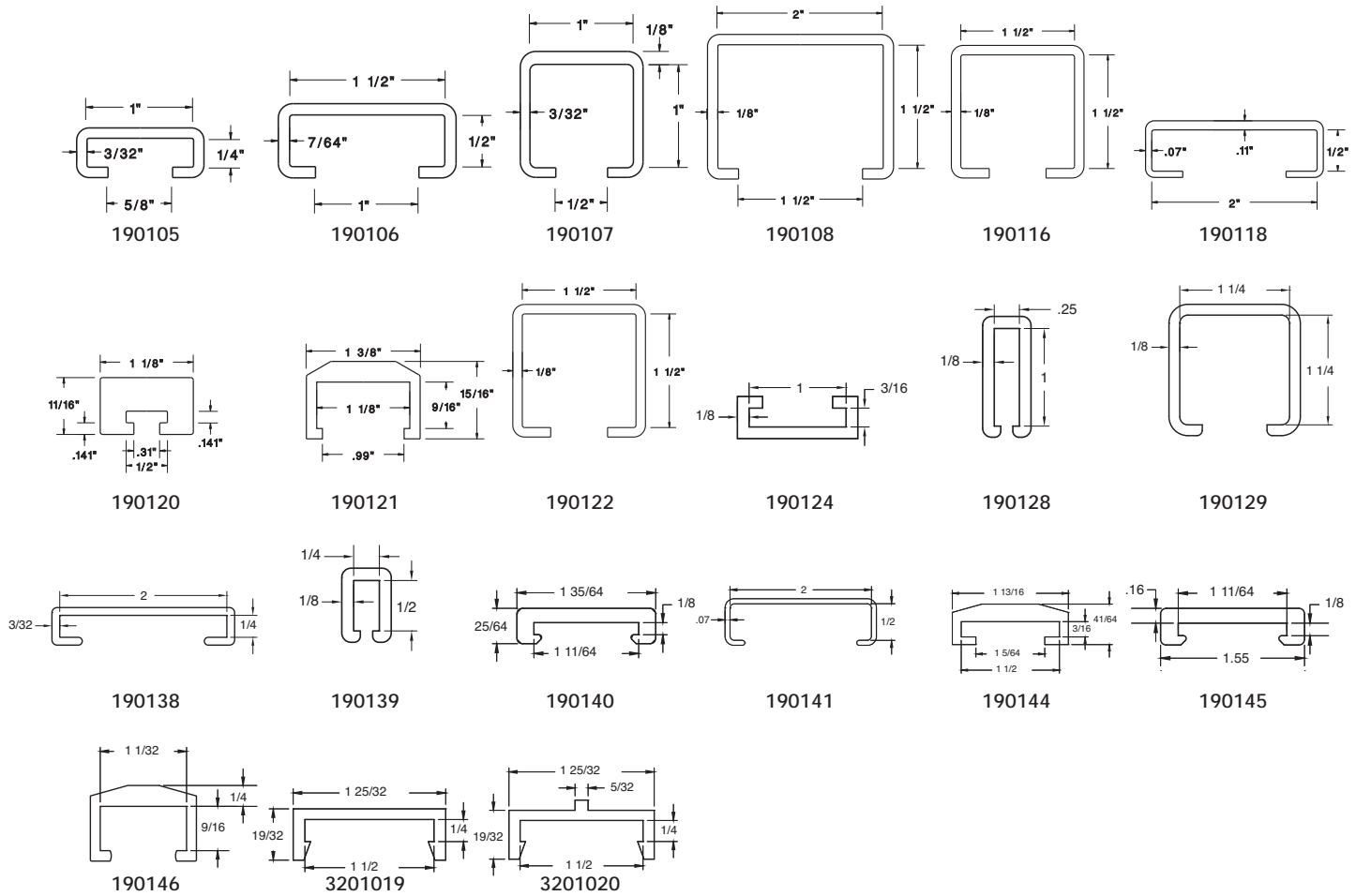

UHMW J-LEG

UHMW J-Leg
for 1/8" Thick Rail

Part No.	A	B	Bar Thickness
210121	1/8	3/4	1/8
210101	1/8	1	1/8
210102	1/8	1-1/2	1/8
210103	1/8	2	1/8
210118	3/16	3/4	1/8
210104	3/16	1	1/8
210119	3/16	1-1/2	1/8
210105	3/16	2	1/8
210120	3/16	2-1/2	1/8
210106	3/16	3	1/8
210107	1/4	1	1/8
210108	1/4	2	1/8
210109	1/4	3	1/8
210183	3/16	1	3/16
210184	3/16	2	3/16
210179	1/4	3/4	3/16
210180	1/4	1	3/16
210181	1/4	2	3/16
210182	1/8	1-1/8	1/4

Edge Guide J-Legs
for 1/8" Thick Rail

Part No.	B	A
210117	1/8	0.96
210130	3/16	0.96
210131	5/16	0.96
210132	1/8	1.00
210133	3/16	1.00

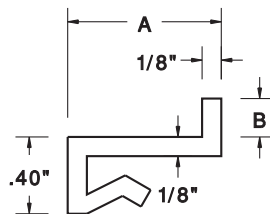

Other Standard Shapes

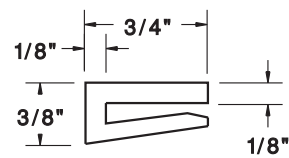

FOR 1/8" RAIL: 210116

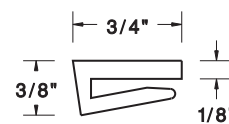

OF/UHMW: 210334

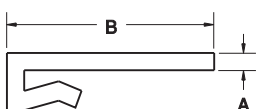

UHMW Snap-Ons Available from stock in 10 or 20 ft. lengths. Smaller sizes in coils.

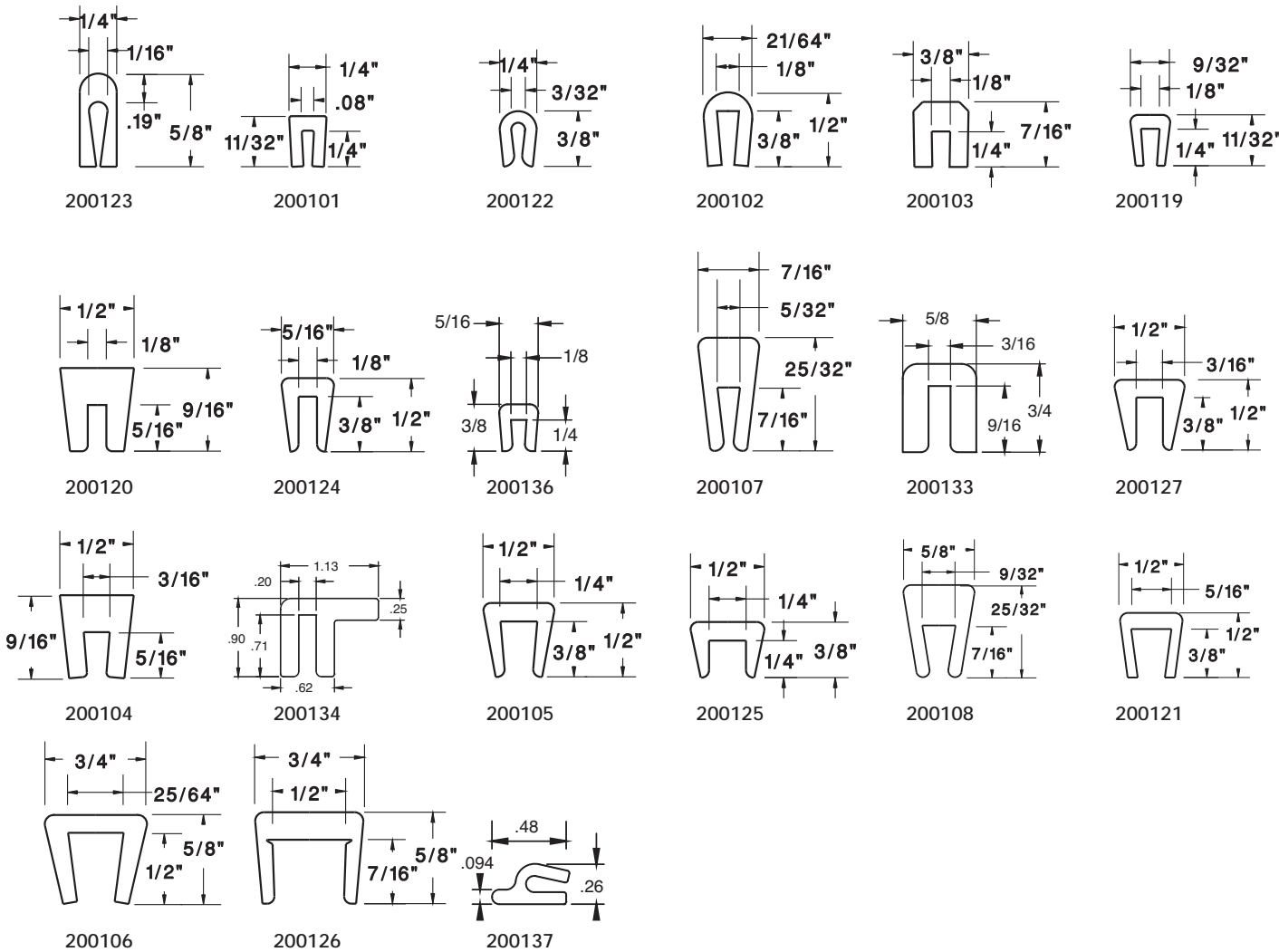

UHMW Full Round

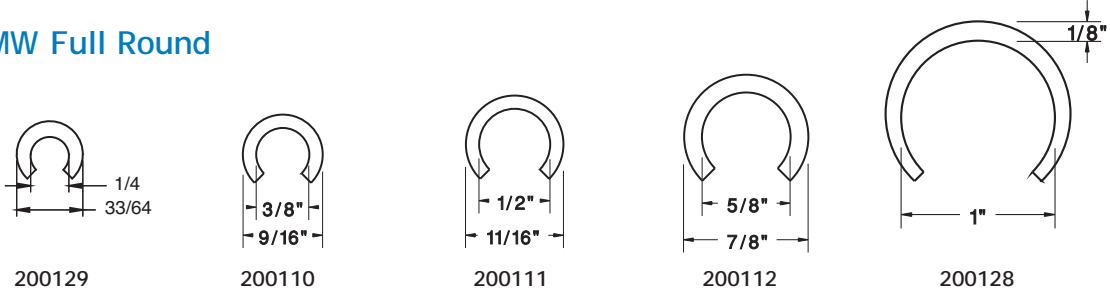

UHMW Half Round

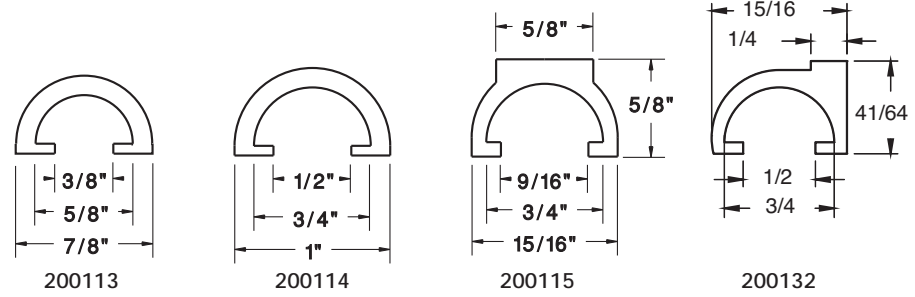

Nylon and High-Temperature Extruded Profile

MD-Nylon Extrusions

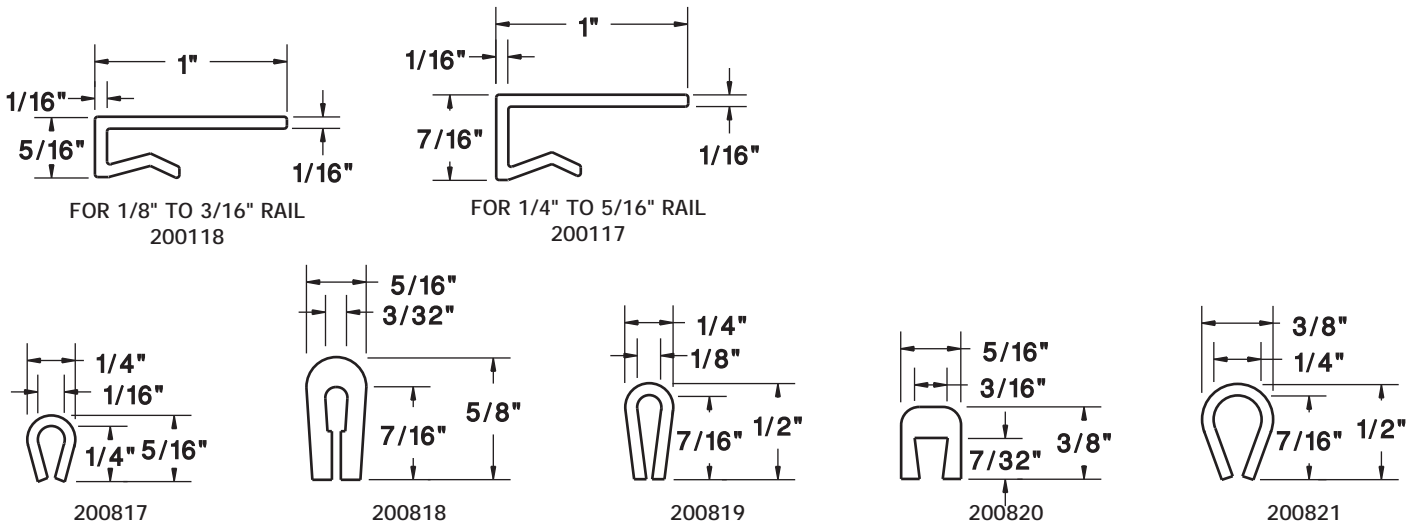

PTFE (Teflon®) High Temperature

PTFE profiles are available for use in applications where general purpose thermoplastic materials are unsuitable. Industries where PTFE guides and wear strips can be found include Bakeries, Food Processing, Chemical Processing and Glass Manufacturing.

The benefits of selecting PTFE are:

- Operating temperature of -350°F to 500°F
- Higher resistance to chemicals allows operation in harsh environments
- Very low coefficient of friction
- Excellent insulating properties for electrical applications
- Approved for direct food contact

Full Round Snap-On

Part No.	ID
201010	3/8
201011	1/2
201012	3/4
201028	1



Half Round Snap-On

Part No.	A	B	C
201023	11/16	1/2	1/4
201013	7/8	5/8	3/8
201014	1	3/4	1/2

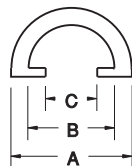

Bar Snap-On

Part No.	A	B	C	D
201019	9/32	11/32	1/8	1/4
201005	1/2	1/2	1/4	3/8
201006	3/4	5/8	3/8	1/2

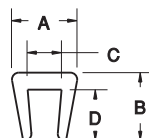

Other Standard Shapes

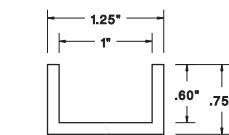

U-CHANNEL: 231021

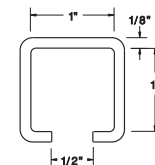

GUIDE RAIL: 191007

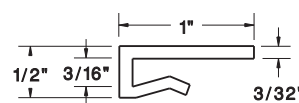

J-LEG: 211001